

Customize your Sorrento Mailbox System by selecting from the options below.

Example Mailbox Assembly Shown Below:

Model #: Sorrento-SDBL-3SM-2-1017-5

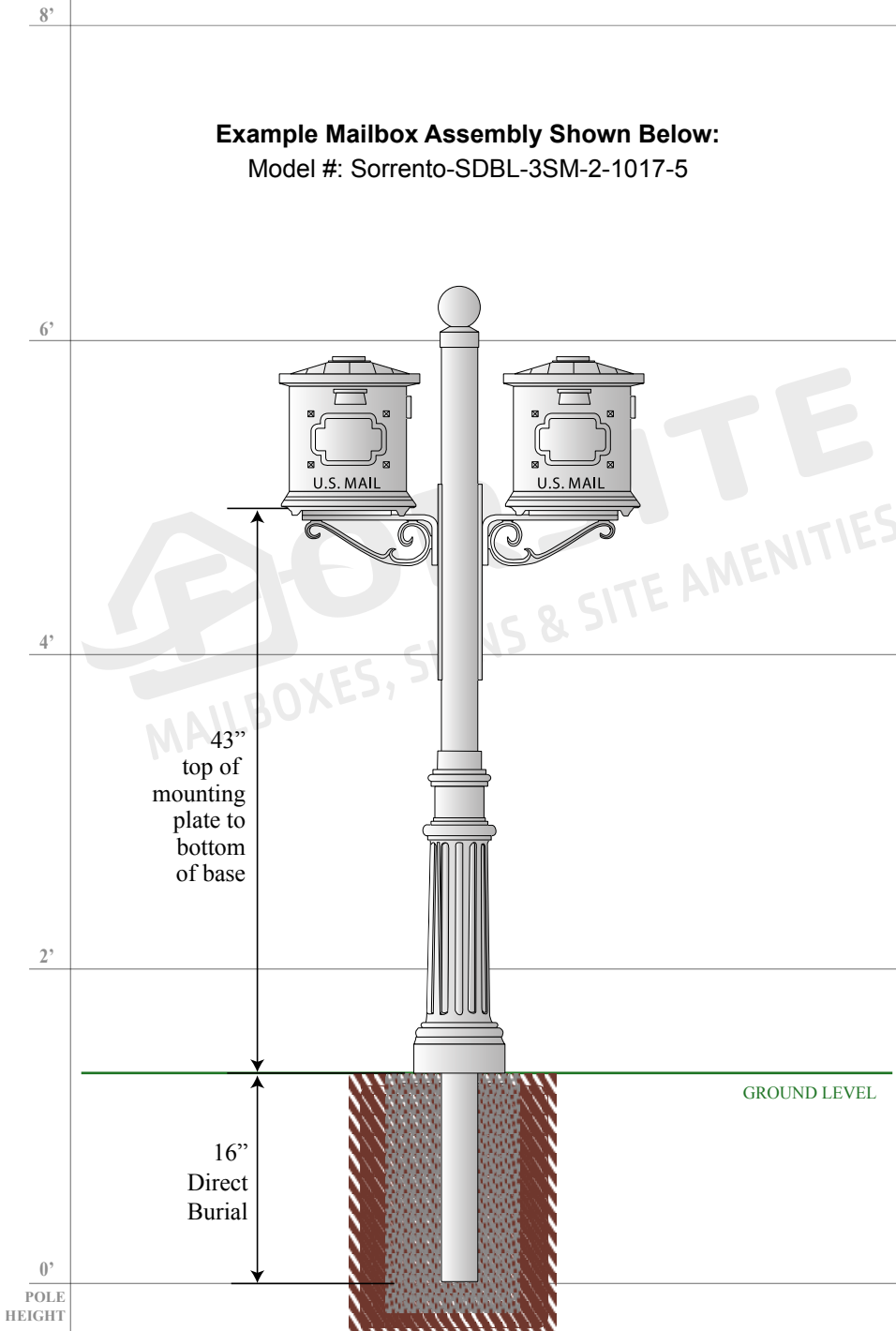

POST OPTIONS:



3SM
3" O/D
Smooth Post



3FL
3" O/D
Fluted Post



4SQ
4" x 4" Smooth
Square Post

POST TOPPER OPTIONS:

FOR 3" ROUND POSTS



FOR 4" x 4" SQUARE POSTS

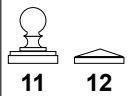

MAILBOX OPTIONS:

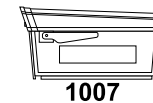

1007

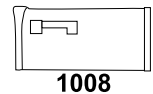

1008

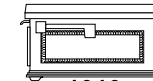

1010

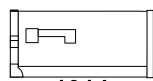

1014

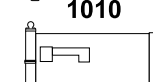

1015

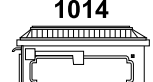

1017

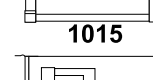

1018A / 1018S

Newspaper tubes are an available option for mailboxes shown (except to 1018A / 1018S)

BASE OPTIONS: (Not required)

FOR 3" ROUND POSTS

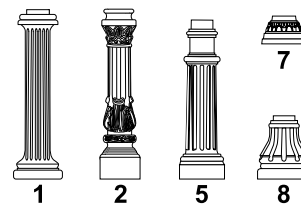

FOR 4" x 4" SQUARE POSTS



3

ADDRESS NUMBERS OPTIONS:

- Polished Brass Self Adhesive Numbers
- Stainless Steel Self Adhesive Numbers
- Gold Reflective Vinyl Numbers
- White Reflective Vinyl Numbers

1234

FORSITE
MAILBOXES, SIGNS & SITE AMENITIES
Phone: 1-855-537-0200
www.forsite.us
customerservice@forsite.us
P.O. Box 51402
Jacksonville, FL 32240

DRAWING NUMBER: 21079-1C

CUSTOMER: N/A

PROJECT: N/A

DRAWING DATE: 07/06/2018

DRAWING DESCRIPTION:

Sorrento Side Double Mailbox Assembly

Forsite is not responsible for checking local municipal codes. Please verify specifications with your municipality before placing an order.

This document contains confidential and proprietary information that is the property of Forsite. It may not be shared, copied or used in whole or in part with third parties without the expressed written consent of Forsite.

FABRICATION TO BEGIN AFTER DRAWING HAS BEEN APPROVED, SIGNED THEN FAXED OR EMAILED TO FORSITE.

Signature: _____ Date: _____